

The image features a large, faint watermark of the Clarion logo and a car stereo unit in the background. The logo is a stylized 'C' followed by 'larion' in a lowercase, sans-serif font. The car stereo unit is a rectangular device with a display screen and various buttons. The background is a light gray gradient with a large, faint circular outline.

Clarion

OHM102/OHM153

OWNERS AND INSTALLATION MANUAL

Warning!

The Clarion OHM102/OHM153 overhead monitor systems are designed for strictly for rear seat entertainment. Viewing the monitor while operating a motor vehicle can result in serious injury and/or property damage. Clarion is not responsible for any injury and/or property damage as a result of the improper use or viewing of the monitor.

Welcome!

Thank you for purchasing the Clarion OHM102/OHM153 overhead monitor system. These monitors are engineered with advanced technological designs and components for the best picture quality and convenience. These overhead monitor systems incorporate a built-in audio/video switcher, PIP (picture in picture), and split screen operation. The split screen operation will allow 2 different A/V sources to be enjoyed simultaneously through dual band IR wireless headphones.

Features:

- . • TFT active matrix display
- . • Left and Right swivel mechanism (OHM102 only)
- . • Built-in dual band IR transmitter for wireless headphones
- . • Built-in PIP/Split Screen functions
- . • External A/V Game Port (Included)
- . • Built-in 4 source A/V input switcher
- . • Built-in dome lights
- . • Front panel menu, picture, and source controls
- . • OSD (On Screen Display) FM modulator control (FM200 not included)
- . • Selectable screen modes: Normal, Zoom, Full, and Wide
- . • Universal mounting bracket
- . • 1/2" rubber gasket
- . • Two dual band IR wireless headphone (WH204H included)
- . • IR remote control
- . • Supports both NTSC and PAL video signals

Introduction

The Clarion OHM102/OHM153 are exclusively designed for the ultimate in rear seat mobile video entertainment. With the built-in A/V switcher, any Clarion video source or game station can be enjoyed on these monitors. The built-in A/V switcher also incorporates PIP (picture in picture) and split screen operation. For added convenience, the front panel controls allows for menu, picture, source, and FM modulator selections. FCC Approval The OHM102/OHM153 has been tested and found to comply within the limits of Part 15B of the FCC rules. These limitations are designed to provide reasonable protection against harmful interference in a residential installation. This equipment generates and uses radio frequency energy and if not installed and used in accordance with the instructions, it may cause harmful interference to radio communications. There is no guarantee that interference will not occur in a particular installation. If this equipment does cause harmful interference to a radio or television reception, turn off the equipment and contact a local Clarion dealer for assistance. Changes or modifications to this product not approved by the manufacturer will void the warranty and violate FCC Approval.

Table of contents

Opening the Overhead Monitor	4
Precautions	5
Care And Maintenance	5
Operating OHM102/153 Monitor	6-9
Operating the Remote Control	10-11
Operating the Headphones	12
Installation Instructions	13-15
Complete System Diagram	16-17
Package Contents	18
Troubleshooting	18
Specifications	19
Warranty Information	20-21

Opening the Overhead Monitor

Press the "OPEN" button to release the overhead monitor. Gently push down on the bottom of the monitor until it reaches the desired position. The monitor will turn on automatically when it is fully open.

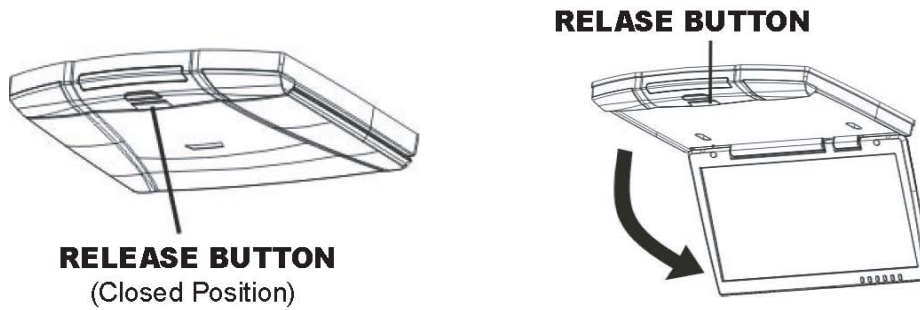

Note: The vehicle's ignition key must be "ON" or Accessory (ACC) position for the monitor to have power.

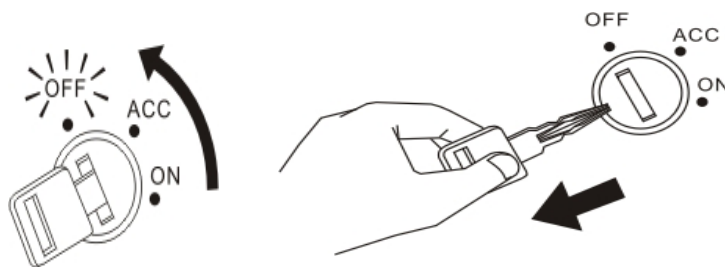

Precautions

- These overhead monitor systems are designed for use in 12V DC negative ground vehicles.
 - Do not operate the overhead monitor system in ways other than described in this manual. Doing so may result in damage to the monitor system and/or vehicle, along with voiding the warranty.
 - **SAFETYFIRST!** These overhead monitor systems are designed for rear seat entertainment only. Do not install in/on dashboard or anywhere else that would allow the operator of the vehicle to view the monitor.
 - Do not disable or modify the overhead monitor system. Doing so may damage the monitorsystem, along with voiding the warranty.
 - Keep all liquids away from the overhead monitor system.
 - Do not leave the overhead monitor system open when not in use. Direct sunlight can cause the monitor not to function properly.
 - In extreme hot and cold temperatures, the movement of the picture may appear to move slow and dark. The overhead monitor system will function properly once the temperature rises.
 - Do not hang or hang items from the overhead monitor system. If you have any questions or problems concerning the monitor that are not covered in this manual, please consult a local Clarion dealer for assistance.
- Before installing this overhead monitor system, please check you local traffic rules and regulations.

Care And Maintenance

Keep all liquids away from the OHM102/OHM153 overhead monitor systems. Liquids inside the monitor will damage the electronics, and result in electrical shock. In the event that the unit should become wet, turn off the power and contact a local Clarion dealer for assistance. To clean the monitor, use a clean soft cloth and gently wipe the screen. If possible, use specially designed "monitor wipes" to clean the screen.

OPERATING OHM102/OHM153 MONITOR

In the event a problem arises with the OHM102/OHM153 overhead monitor system, do not attempt to disassemble or repair the monitor yourself. Opening or attempting to service the monitor will void the warranty; instead contact a local Clarion dealer for assistance.

Monitor Control Panel

1. PIP (Picture In Picture) button

Press the PIP button to enable Picture In Picture or split screen operation.

2. MENU button

Press the MENU button to access the monitor adjustments.

FM MOD ON/OFF>Brightness>Contrast>Saturation>Hue>Sub Size>Sub Position> Default Reset.

3. DOWN button

MENU, then DOWN selects item to be adjusted.

DOWN: Also selects Main AV source.

4. UP button

MENU, then UP selects item to be adjusted. UP: Also selects Sub Screen AV source.

5. DIMMER button

Press to adjust the brightness of the screen.

6. MODE button

Press to change the screen format: Normal, Full, Zoom, and Wide.

7. OPEN button

Press to open the overhead monitor.

8. IR Transmitter for wireless headphones and IR Receiver for remote control

Note: Also functions as the dome light ON/OFF switch for the OHM102 only.

9. Dome light switch

Dome light switch for the OHM153

10. Dome lights

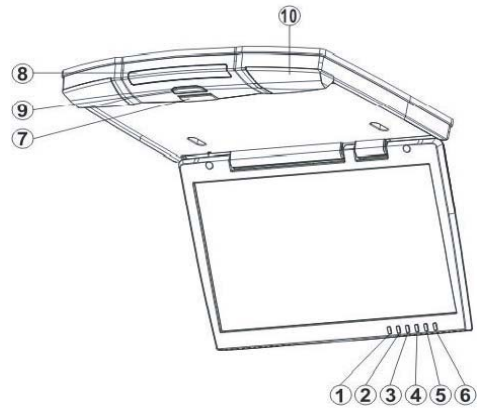

Closing the Overhead Monitor

Gently push the backside of the monitor until it clicks into the overhead monitor housing. The monitor will turn off automatically when it is returned to the closed position.

Note: Do not place any objects between the monitor and the monitor housing, this can result in serious damage to the monitor.

Adjusting the Tilt and Swivel (OHM102 only)

The monitor can be opened to a maximum of 110 degrees. Exceeding this point can cause serious damage to the monitor and monitor housing. **Note:** The OHM102 has the capability of swiveling the monitor left and right. Prior to closing the monitor, it is important that the monitor be returned to the center position.

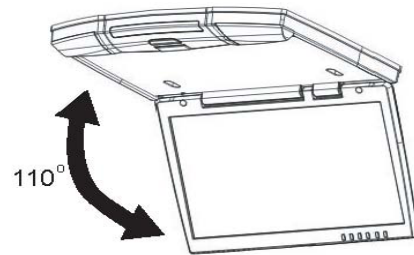

Setting the Screen Mode

The OHM102/OHM153 has 4 different screen modes: NORMAL, WIDE, ZOOM, and FULL. Pressing the MODE button on the front control panel or the remote control can access the different screen modes. The current mode is displayed on the screen first. Each time the MODE button is pressed, the screen mode switches in the following sequence:

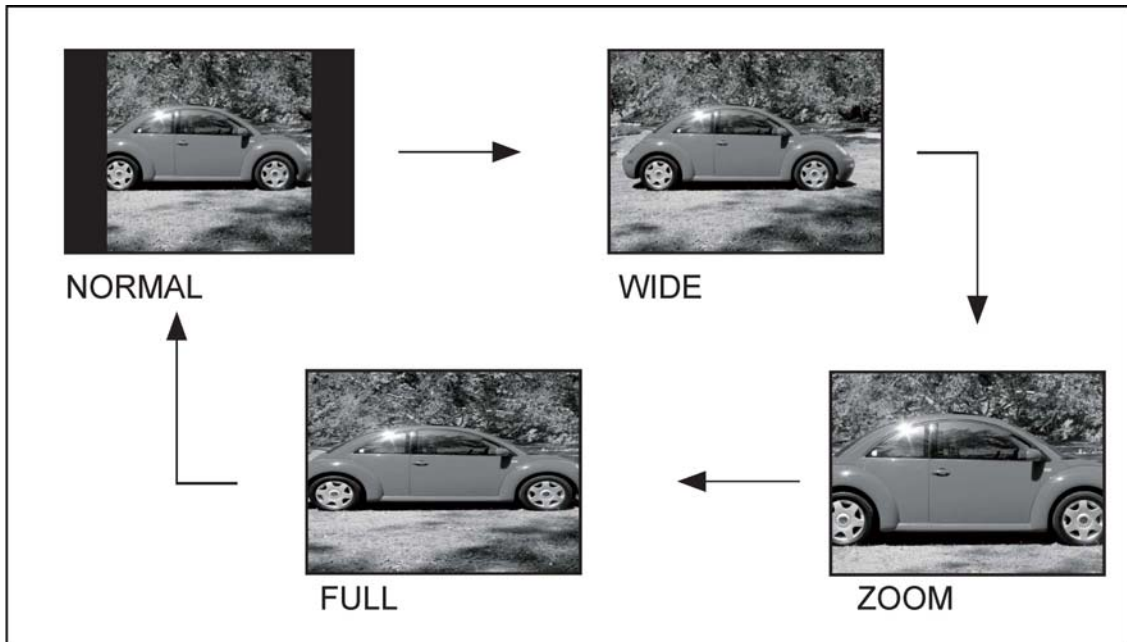

Note: The screen mode will set after 5 seconds, pending that the MODE button is not pressed.

The display image may appear coarse or grainy when viewed in Zoom mode.

Changing the Display Settings (Picture In Picture/Split Screen)

The display setting can be adjusted by pressing the PIP (Picture In Picture) button on the control panel or remote control. This button selects between PIP and split screen viewing mode. In PIP mode, the second image can be displayed in any of the four corners and in four different viewing aspects. In split screen mode, the display is evenly divided between two AV sources.

To access PIP or split screen display setting, press the PIP button until the desired mode is displayed. The screen will change in the following sequence:

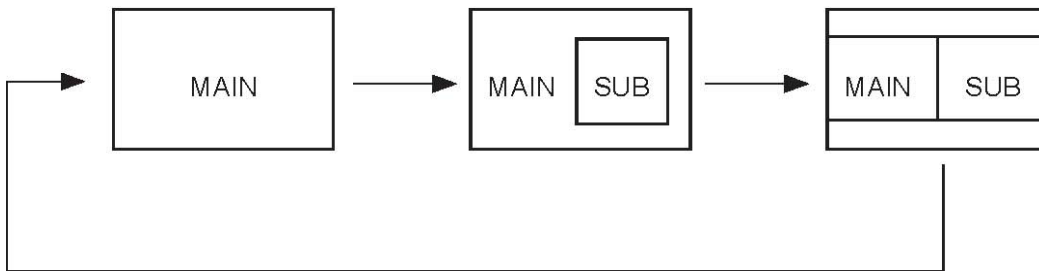

Selecting the AV Sources for Main and Sub Screen

MAIN SCREEN

Press the ▼ (DOWN Button) to select the desired AV source. The sources will be changed in following sequence:



SUB SCREEN

Press the ▲ (UP button) to select the desired AV source. The sources will be changed in following sequence:

NOTE: Same video input cannot be viewed simultaneously.

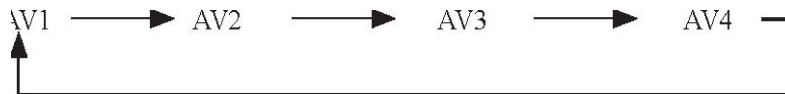

Dimmer Button:

Press the DIMMER button to adjust the brightness of the screen. The brightness will change in the following sequence:

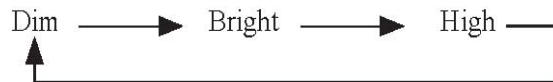

OPERATING THE REMOTE CONTROL

1. Power button

Press the Power button to turn ON/OFF the monitor.

2. FM button

Press to turn ON/OFF the FM modulator (FM200 not included)

3. DIMMER button

Press to adjust the brightness of the screen.

4. MENU button

Press the MENU button to access the monitor adjustments.

FM MOD ON/OFF>Brightness>Contrast>Saturation>Hue>Sub Size>Sub Position> Default
Reset

▼ (Down button)

MENU, then DOWN selects item to be adjusted.

DOWN: Selects Main AV source.

▲ (Up button)

MENU, then UP selects item to be adjusted. UP:

Select Sub Screen AV source.

MAIN

MODE button

Press to change the screen format: Normal, Full, Zoom, and Wide.

INPUT button

Press to select AV source for Main Screen.

PIP button

Press to select PIP (Picture In Picture) or split screen operation.

SWAP button

Switches the PIP (Picture In Picture) with the Sub image.

SUB

POS button

Press to select the location of the PIP (Picture In Picture) image.

SIZE button

Press to select the size of the PIP (Picture In Picture) image.

INPUT button

Press to select AV source for Sub Screen.

Mode button

Press to change the screen format: Normal, Full, Zoom, and Wide.

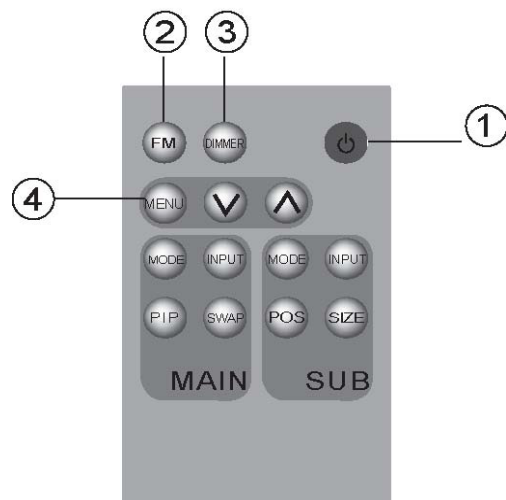

Battery Installation

1. Slide the battery-retaining clip in, while sliding the battery tray out.
2. Insert the CR2025 lithium battery into the tray with the "+" facing upwards.
3. Slide the battery tray back into the remote control.

Note: Under normal conditions the battery should last approximately one year. When the battery becomes weak, the transmitting range of the remote control will shorten.

Replacing the battery with anything other than a CR2025 battery can damage the remote control.

OPERATING THE HEADPHONES

1. Power switch

Press to activate the headphones. The power on the headphones will turn off automatically, if an audio signal is not detected for over a minute.

2. Source selector switch

Switches between the audio sources.

3. Volume adjustment switch

Adjusts the volume of the sound in the headphones

Note:

- Headphones are not to be worn by the operator of the vehicle when driving.
- Do not leave the headphones in a place subject to direct sunlight or extreme temperatures.
- If the headphones are exposed to direct sunlight for an extended period of time, the sensitivity of the IR receiver maybe affected causing poor sound quality. Allow headphones to cool off before using.



Battery Installation

1. Slide the battery cover door downwards.

2. Insert 2 new “AAA” batteries into battery holder, following the diagram inside the battery holder.

3. Slide the battery cover door back onto the headphones. **Note:**

When the batteries become weak in the headphones, the audio can sound distorted or cut in and out.



INSTALLATION INSTRUCTIONS

About the Installation

The installation of the OHM102/OHM153 overhead monitor system requires experience in both mechanical and electrical procedures. If you do not possess the necessary experience or tools to attempt this installation, contact a local Clarion dealer for assistance. Improper installation can result in damage to the monitor and/or the vehicle.

This manual provides basic installation tips and techniques to aid in the installation of the OHM102/OHM153 overhead monitor systems. The installation instructions are not vehicle specific, it's a guideline on how to perform the installation.

Prior to Beginning Installation

- . • Verify that all of the functions of the vehicle work properly (i.e.: power windows, power door locks, air conditioning, Dome-lights, etc.)
- . • Verify the monitor will not interfere with the operation of the sunroof, if applicable.
- . • Test the location of the overhead monitor system to ensure it will not interfere with the safe operation of the vehicle.
- . • Determine the location of the AV source(s).

Installation Procedure

1. Identify the polarity of the dome light circuit and set the switch on the bottom of the overhead monitor housing. The switch allows you to switch between a positive or negative Dome-Light input signal.
2. Test the overhead monitor system on the ceiling of the vehicle, verifying it's not going to interfere with the safe operation of the vehicle.
3. Once the mounting location of the overhead monitor system has been determined, carefully mark the location with masking tape.

4. Lower the vehicle's headliner down to see if a roof support beam is available to screw the mounting bracket onto. If a support beam is not available to screw into, use a $\frac{3}{4}$ " piece of plywood cut to the appropriate size. Attach the plywood to the roof of the vehicle using silicone allowing adequate drying time.

5. Screw the mounting bracket in the vehicle. **DOUBLE CHECK THE LENGTH OF THE SCREWS PRIOR TO MOUNTING THE BRACKET.**

6. Cut a 1" hole in the headliner along the backside of the mounting bracket for the cables to pass through.

7. Route cables through the hole to the predetermined location of the AV source(s).

8. Identify the dome light wires in the vehicle and connect them to the corresponding dome light wires on the overhead monitor system.

9. Plug in the AV cables and power harness into the overhead monitor system.

10. Carefully hold the overhead monitor system to the mounting bracket aligning the mounting holes while screwing in the screws. (Make sure the wires and cables are not in the way while mounting the monitor.)

11. Connect the Red wire of the power harness to the Accessory wire in the ignition harness.

12. Ground the Black wire of the power harness to a clean ground spot.

Note: Make sure you keep the ground wire of the OHM102/OHM153 and video source as short as possible to prevent any type of unwanted vehicle noise.

Roof Beam Headliner

Optional Spacer Material
(Installer Provided)



Screws (Not Provided)

Metal Bracket (Included)



Screws (Not Provided)

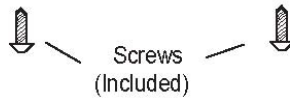

Screws
(Included)

WARNING!

Make sure that the screws you use to mount the bracket, monitor, or optional spacers are not too long! If the screws are too long, they could damage the roof of the vehicle. Take great care when planning this part of the installation

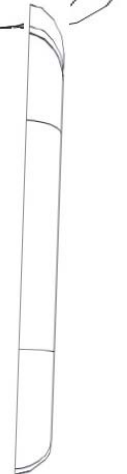

COMPLETE SYSTEM DIAGRAM

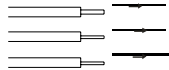
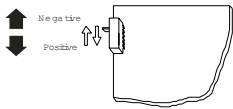
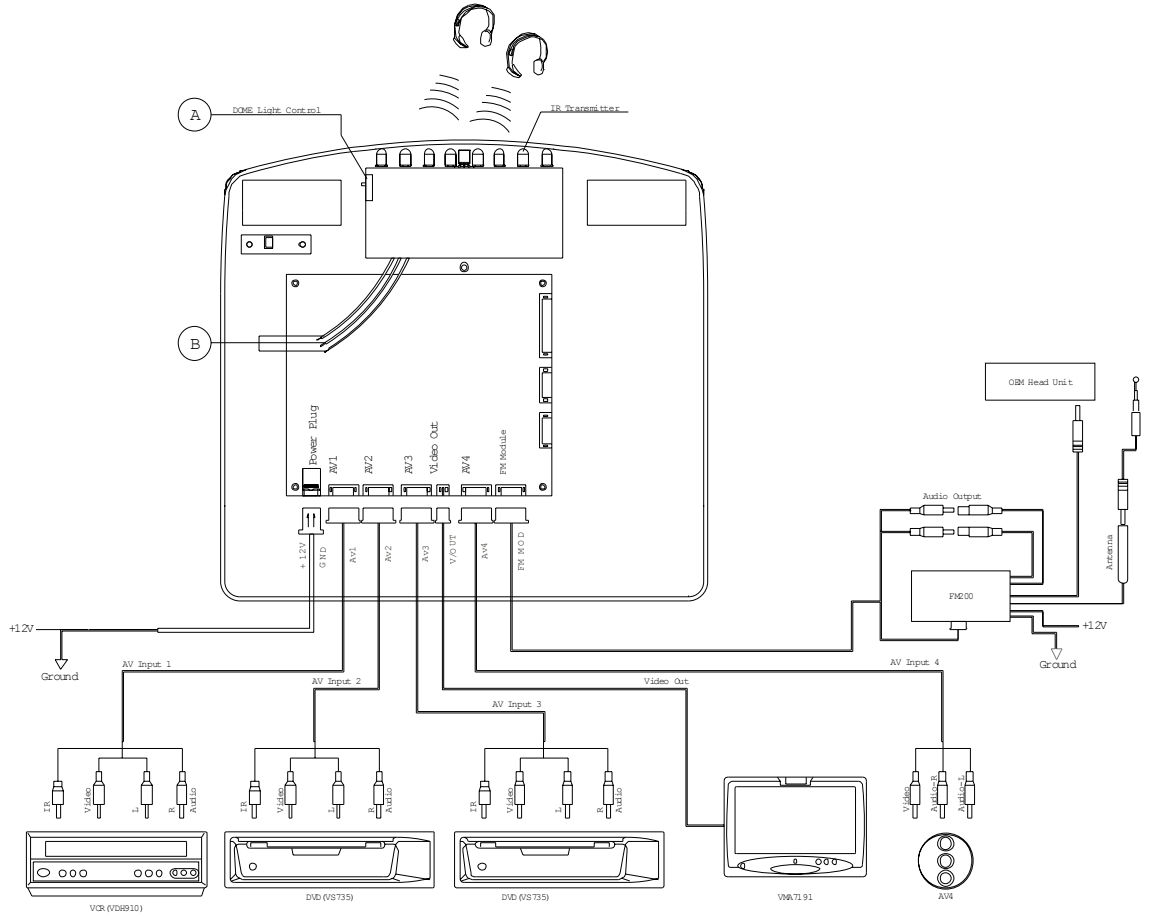

Connection Diagram

Please refer to the connection diagram on Page 16 for the proper wiring conditions for the OHM102/OHM153 overhead monitor. If you are uncertain as to what the proper connections are please contact a qualified Clarion technician for further installation assistance.

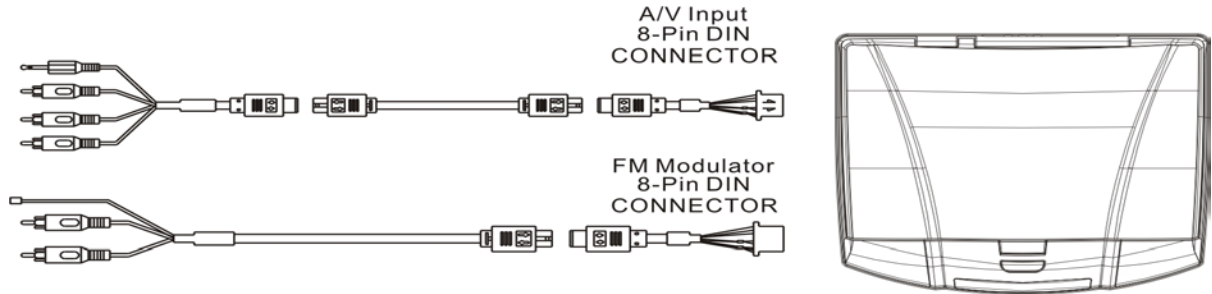

A/V Input 8-Pin DIN Connector	
Pin	Function
1	AUDIO LEFT INPUT
2	NC
3	AUDIO RIGHT INPUT
4	NC
5	VIDEO INPUT
6	NC
7	IR OUTPUT
8	NC
GND	A/V GND SHIELDING

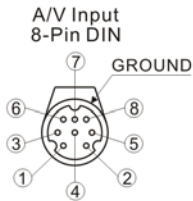

FM Modulator 8-Pin DIN Connector	
Pin	Function
1	NC
2	NC
3	NC
4	NC
5	FM MOD ON/OFF
6	AUDIO LEFT OUTPUT
7	NC
8	AUDIO RIGHT OUTPUT
GND	AUDIO GND SHIELDING

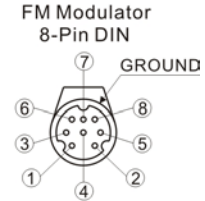

PACKAGE CONTENTS

- 1 OHM102 Or 1 OHM153
- 2 Audio Video RCA Accessories
- 2 Audio Video Din Cables
- 1 Convenient External Game Port
- 1 Audio Output Din Cable
- 1 Two-Pin Power Harness
- 1 Metal Mounting Bracket
- 4 Screws For Metal Mounting Bracket
- 1 Soft Black Rubber Gasket
- 1 Remote Control (RCL 123)

TROUBLESHOOTING

No Picture

Press the POWER and SOURCE buttons to make sure the monitor is on and the proper input is selected. If there is still no picture press the PICTURE button. If the menu appears, check the source unit and video connections. If NO MENU appears, check all fuses and power connections to the OHM102/OHM153.

NOTE: *The OHM102/OHM153 has an operating temperature of apr. 5 degrees C to 40 degrees C (41 degrees F to 104 degrees F.). If the temperature is outside this operating range, the unit will turn on, or the screen may be slow to react to image changes. The monitor will function normally once it returns to its proper operating temperature range.*

With a DVD player and a widescreen DVD disc, there are black bars on the screen.

Change the TV display mode to "WIDE" in the DVD player's setup menu. After changing this setting, if there are still black bars, press the WIDE/NORMAL button on the OHM102/OHM153 remote control.

SPECIFICATIONS

Supply: 12V DC (10V-16V)

Test Voltage: 12V, negative ground

Current Consumption: (OHM102) 1 Amp, (OHM153) 1.9 Amps

Max Current Consumption: (OHM102) 1.1 Amps, (OHM153) 2 Amps

Operating Temperature: (OHM102) 0 ~ 60 C, (OHM153) 0~50 C

Storage Temperature: (OHM102) -30 C ~ 85 C (OHM153) -20 C ~ 60 C

Video System: Auto NTSC and PAL

Screen: (OHM102) 10.2" Diagonal (OHM153) 15.3" Diagonal

Resolution: (OHM102) 800 X 480 (OHM153) 1280 X 768

Weight: (OHM102) 2.6lbs, (OHM153) 5.2lbs

Video Signal: 1Vp-p with 75-ohm load

The technical data and design of the equipment may change for the sake of technical improvements without prior notice.

WARRANTY INFORMATION

This product is warranted against all defects in material workmanship for a period of one year from the date of original purchase. Clarion Pro Audio products, except for speakers, are covered by a two year limited warranty when installed by an authorized Clarion dealer. The conditions of this limited warranty and the extent of responsibility of Clarion Corporation of America ("Clarion") under this limited warranty are as follows:

1. PROOF OF DATE OF PURCHASE WILL BE REQUIRED FOR WARRANTY SERVICE OF THIS PRODUCT. IN THE CASE OF THE TWO (2) YEAR LIMITED WARRANTY FOR CLARION PROAUDIO PRODUCT, PROOF OF INSTALLATION BY AN AUTHORIZED DEALER IS REQUIRED. INFORMATION ABOUT CLARION AUTHORIZED WARRANTY SERVICE CENTERS MAY BE OBTAINED BY CONTACTING OR WRITING CLARION AT THE ADDRESS LISTED BELOW.
2. This limited warranty will become void if service performed by anyone other than an approved Clarion Warranty Service Center results in damage to the product.
3. This limited warranty does not apply to any product which has been subject to misuse, neglect or accident, or which has had the serial number altered, defaced or removed, or which has been connected, installed, adjusted or repaired, other than in accordance with the instructions furnished by Clarion.
4. This limited warranty does not cover car static or other electrical interferences, tape head or laser pick-up cleaning or adjustments, or labor costs for the removal or reinstallation of the unit for repair
5. The sole responsibility of Clarion under this limited warranty shall be limited to the repair of the product or replacement of the product, at the sole discretion of Clarion.
6. Product must be shipped in its original carton or equivalent carton, fully insured, with shipping charges prepaid. Clarion will not assume any responsibility for any loss or damage incurred in shipping.

7. ALL IMPLIED WARRANTIES EXCEPT TO THE EXTENT PROHIBITED BY APPLICABLE LAW SHALL HAVE NO GREATER DURATION THAN THE WARRANTY PERIOD SET FORTH ABOVE. UNDER NO CIRCUMSTANCES SHALL CLARION BE LIABLE FOR ANY LOSS OR DAMAGE, DIRECT OR CONSEQUENTIAL, ARISING OUT OF THE USE OR INABILITY TO USE THE PRODUCT. BECAUSE SOME STATES DO NOT ALLOW LIMITATIONS ON HOW LONG AN IMPLIED WARRANTY LASTS OR EXCLUSIONS OR LIMITATIONS OF INCIDENTAL OR CONSEQUENTIAL DAMAGES, THE ABOVE LIMITATIONS OR EXCLUSIONS MAY NOT APPLY TO YOU.

1. 8. THIS LIMITED WARRANTY GIVES YOU SPECIFIC LEGAL RIGHTS, AND YOU MAY ALSO HAVE OTHER RIGHTS WHICH VARY FROM STATE TO STATE.

2. 9. Should you have any difficulties with the performance of this product during the warranty period, please call or visit our web site for a listing of Authorized Warranty Service Centers in your area. You may also contact the Clarion Customer Service at the address listed below for any service help you may need with Clarion products.

**CLARION CORPORATION OF AMERICA 661 WEST REDONDO BEACH BLVD., GARDENA,
CA 90247 www.clarion.com**

NOTES:

**CLARION CORPORATION OF AMERICA 661 WEST REDONDO
BEACH BLVD., GARDENA, CA 90247 www.clarion.com**